

REVISIONS

REV.	DESCRIPTION	DATE	APPRVD.

Notes:

1. Quick Connect Cable is only available for 2 unit Multi-System. When Quick Connect Cable is in use, pump control and tub alarm features are disabled.
2. When connecting 2 devices, use only a single remote controller.
3. Size the piping to allow for the maximum flow rates of the units (1" - 1 1/4").
4. Noritz recommends the use of Isolation Kit (IK-WV-4) with installation. These kits include an integrated shut-off and service valve with unions and a pressure relief valve.
5. Size the pump to provide a maximum of 3 GPM with a head pressure equal to the loss through the water heater and Air Handler.
6. Check valve required if it is not included with the pump.
7. If the system requires water for space heating at a higher temperature than for other uses, mean such as a mixing valve shall be provided to temper the water for the other uses to help prevent scalding.
8. Expansion tank required if a backflow preventer is installed.

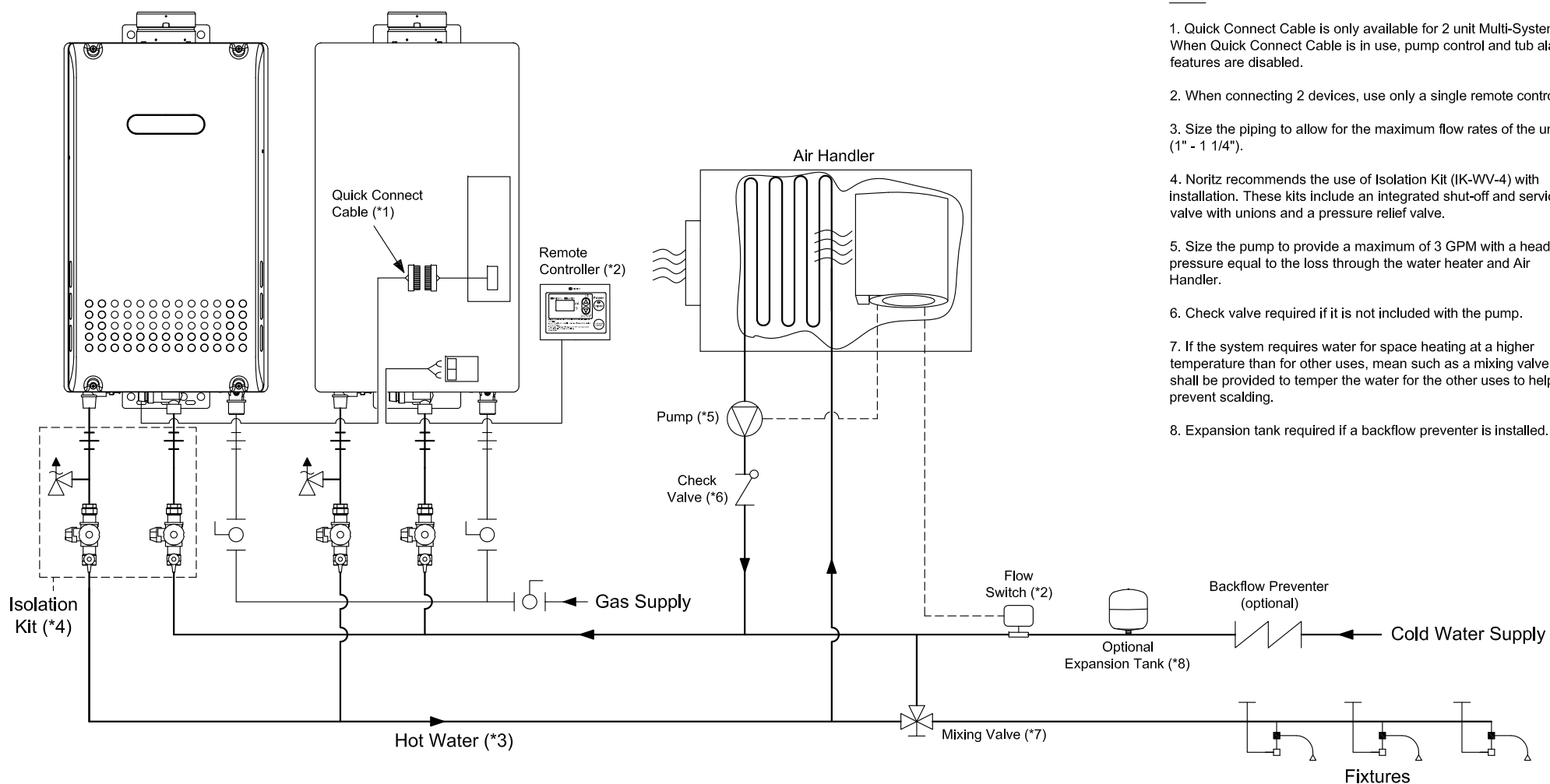

NORITZ
 11160 Grace Avenue
 Fountain Valley, California 92708
 866-7NORITZ (866-766-7489)
 www.noritz.com





MODEL:
 N-0751M

APPLICATION:
 Quick Connect
 Domestic Hot Water
 Hydronic Heating









DRAWING NUMBER:
 (6a2)N751M

DRAWING DATE:
 September 22, 2008

Noritz Accessories

-  RC-7649M (Remote Controller)
-  RC-CORD10 (10' Remote Controller Cord, optional in 26')
-  VC-4-1 (Outdoor Vent Cap, place on top of unit)
-  QC-1M (Quick Connect Cable, for 2 unit Multi-System)

Note: This diagram is for reference only. Installation must comply with State and Local Code, all gas and water pipe must be sized correctly to specific length, according to accepted engineering methods or the UPC Code for Noritz Water Heaters to operate correctly.

-  Shut-off Ball Valve
-  Check Valve
-  Union
-  Pressure Relief Valve (Watts 3L, Zurn P1000A, Cash Acme FWL-2)
-  Aquastat (Honeywell Model #L6006A or L6006C)
-  Pump
-  Mixing valve
-  Thermal Expansion Tank