



Installation Instructions for RB-600 Recess Box

(For Models N-0631S-OD and NR71-OD)

1) Determine the installation location.

- The recess box should be installed so the discharge vent maintains the minimum allowable clearances as required by the local authority. Where no local requirement exists, maintain the following minimum suggested clearances from building openings as shown in Figure 1:

1' below, 1' horizontally from, or
1' above any door, operable window,
or gravity air inlet into any building.
3' above any forced air inlet within 10'.

- Follow all other installation requirements as outlined in the Installation Manual.

Note: Top, front, and side clearances noted on the front cover of the water heater are not applicable when installed in a recess box.

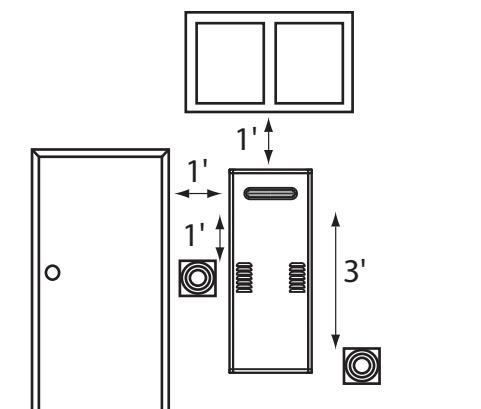

Figure 1: Discharge Vent Clearances.

Warning

This recess box has been designed to be mounted in a wall cavity. Do not attempt to mount the recess box in another configuration (i.e. outside wall, free standing, etc.). Damages resulting from an improper installation will not be covered by the Noritz America Limited Warranty.

2) Construct the framing.

- Prepare an opening for the recess box to the following approximate dimensions:
39-1/2" (height) x 14-1/4" (width) x
7-1/2" (depth)

Note: The recess box is approved for zero clearance to combustibles.

3) Prepare the recess box.

- Drill 3 holes in the recess box to accommodate the water and gas lines. Suggestions for the holes are shown in Figure 2. Additional holes for running the electrical and remote controller wires will be needed as well.

SIDE ENTRY

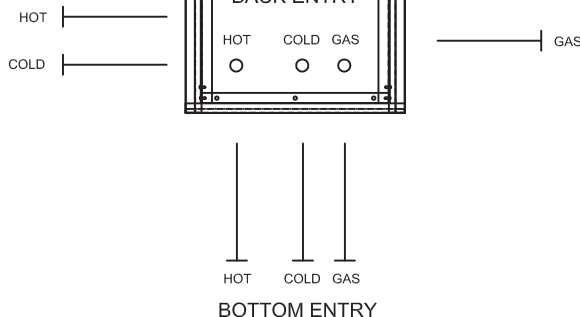

Note: Allow for drainage from the pressure relief valve.

Figure 2: Piping options.

4) Install the recess box.

- Attach the recess box to the framing using suitable screws on all 4 sides of the box.

5) Install the heater.

- First, install one of the supplied mounting screws in the top recess box bracket leaving about 1/4" clearance between the bracket and screw.
- Second, insert the water heater into the box by sliding the top heater bracket over the previously installed mounting screw as shown in Figure 3.
- Finally, install the 2 remaining mounting screws in the lower recess box brackets and tighten all 3 screws to secure the heater (see Figure 4).

6) Make connections.

- Connect water, gas, and electrical connections as outlined in the Installation Manual.

7) Seal the Recess Box.

- Using silicone, seal around the outer edges of the box as well as around any penetrations made to prevent water leakage.

Note: The lower, inner edges of the box have been pre-sealed. If these seals are damaged, reseal them using silicone.

8) Replace the Recess Box Cover.

- After confirming the heater is operating correctly, replace the front cover of the recess box as shown in Figure 5.

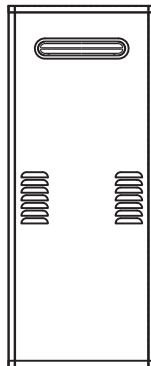

Figure 5: Completed installation.

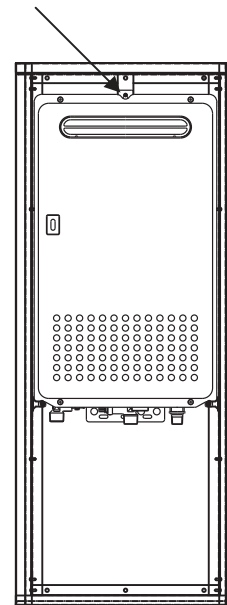

Figure 3: Location of top mounting bracket.

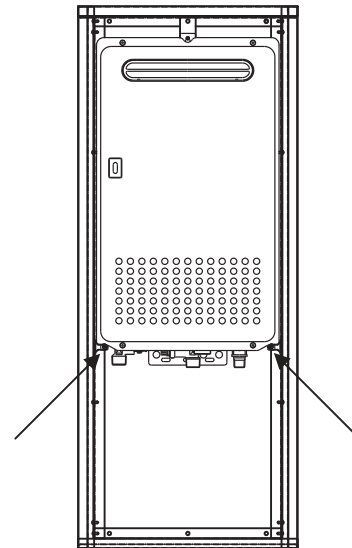

Figure 4: Location of lower mounting brackets.

 **Warning**

Do not use the recess box for storage. Using the box for other than its intended use can pose a fire hazard.