

REVISIONS

REV.	DESCRIPTION	DATE	APPRVD.

Notes:

- Noritz recommends the use of Isolation Kit (IK-WV-7) with installation. Connections are available in Threaded or Sweat. These kits include an integrated shut-off and service valve with unions and a pressure relief valve.
- Wire aquastat to pump according to "Circulation Pump to Aquastat Wire Diagram (PAWD.pdf)." Set the aquastat to 10°F below the set output temperature.
- Size the pump to provide a maximum of 1.5 GPM through the system at 10 ft of head plus piping losses. Adjust the flow using a globe valve and verify the flow rate with the maintenance monitors.
- Size the pump to provide enough flow through the water heater and Brazed Plate Heat Exchanger. Refer to the manufacturer for flow requirements and performance data.
- Check valve required if it is not included with the pump.
- If the system requires water for space heating at a higher temperature than for other uses, means such as a mixing valve shall be provided to temper the water for the other uses to help prevent scalding.
- Expansion tank required if a backflow preventer is installed.

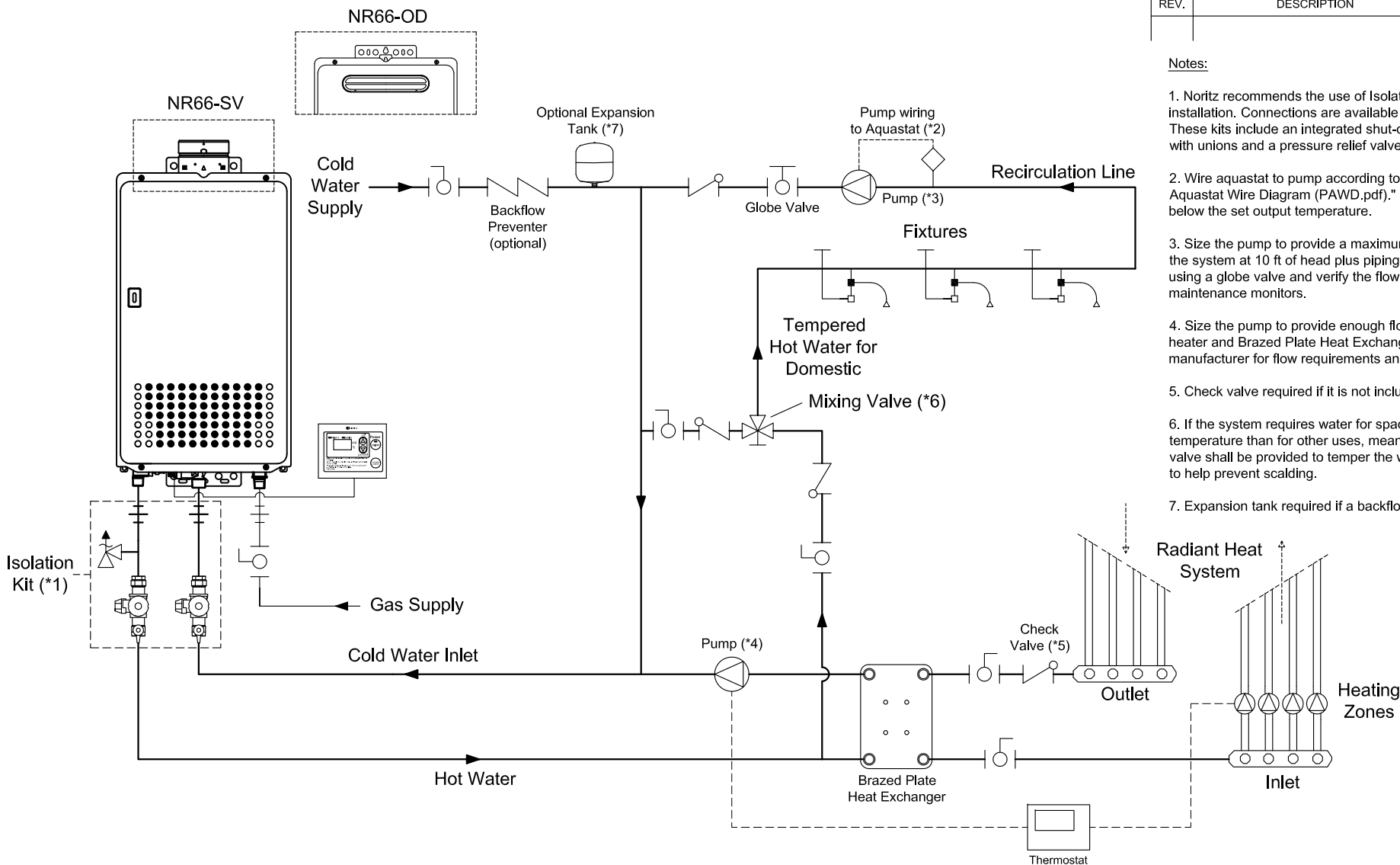

**NORITZ**  
 11160 Grace Avenue  
 Fountain Valley, California 92708  
 866-7NORITZ (866-766-7489)  
 www.noritz.com



**MODEL:**  
 NR66 Series

**APPLICATION:**  
 Radiant Heating  
 Domestic Hot Water  
 Recirculation Loop









**DRAWING NUMBER:**  
 (7b1)NR66

**DRAWING DATE:**  
 November 17, 2009

**Noritz Accessories**

-  RC-7649M (Remote Controller, Optional with NR66/NR71)
-  RC-CORD10 (10' Remote Controller Cord, optional in 26')
-  VC-3 (Outdoor Vent Cap for -SV model only)

*Note: This diagram is for reference only. Installation must comply with State and Local Code, all gas and water pipe must be sized correctly to specific length, according to accepted engineering methods or the UPC Code for Noritz Water Heaters to operate correctly.*

-  Shut-off Ball Valve
-  Check Valve
-  Union
-  Pressure Relief Valve (Watts 3L, Zurn P1000A, Cash Acme FWL-2)
-  Aquastat (Honeywell Model #L6006A or L6006C)
-  Pump
-  Mixing Valve
-  Thermal Expansion Tank