



Installers Guide 2012

Version 1



Table of Contents

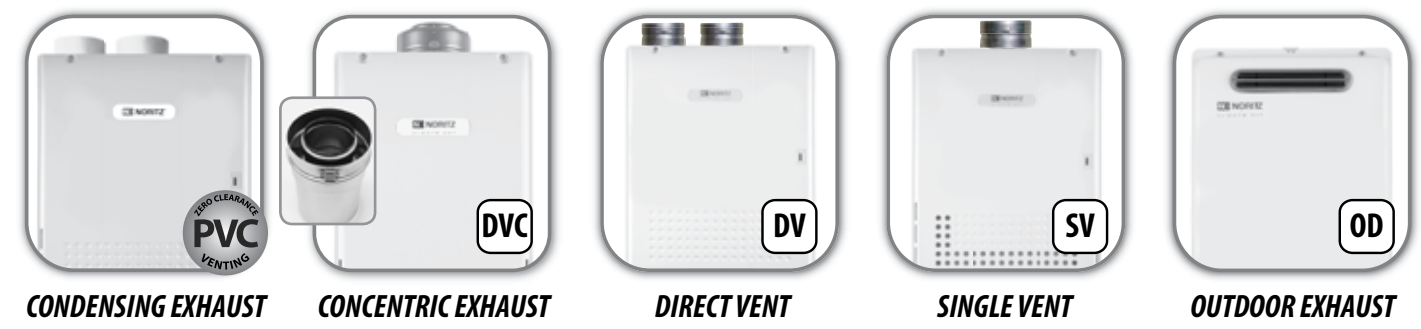

WATER HEATERS **3**

ACCESSORIES **6**

SINGLE WALL VENT **9**

CONCENTRIC VENT **13**

PVC VENT **15**

VENT ACCESSORIES **16**

SUS VENT KITS **18**

VENTING DIAGRAM **19**



NHXXX-DV
Hydronic
Boiler

Model No.	Description
NH199-DV	Residential/Commercial Boiler, 199,900 Btuh, ASME certified
NH150-DV	Residential/Commercial Boiler, 150,000 Btuh, ASME certified



NC380-SV-ASME
Commercial
Water Heater

Model No.	Description
NC380-SV-ASME	Indoor/Outdoor, 380,000 Btuh, max.13.2 gpm, ASME stainless steel



NC250-ASME
Commercial
Water Heater

Model No.	Description
NC250-DV-ASME	Indoor Direct Vent, 250,000 Btuh, max. 11.1 gpm, ASME stainless steel
NC250-SV-ASME	Indoor/Outdoor, 250,000 Btuh, max. 11.1 gpm, ASME stainless steel



NCC1991
Commercial
Condensing
Water Heater

Model No.	Description
NCC1991-DV	SV Convertible, Low NOx, Indoor Direct Vent, 199,900 Btuh, max. 11.1 gpm, stainless steel
NCC1991-OD	Low NOx, Outdoor, 199,900 Btuh, max. 11.1 gpm, stainless steel



SUPPORT SITE & CALL CENTER
 Noritz America recently unveiled two customer-service initiatives – a Technical Support Web Site and an In-House Call Center – with the goal of delivering information more quickly and efficiently to customers, whether their preferred method is the telephone or online.

SUPPORT.NORITZ.COM • 866.766.7489

Add “-NG” or “-LP” to the end of the model number to specify gas type.

**NC199/
NC1991**
Commercial
Water Heater



Model No.	Description
NC199-DVC	Indoor Concentric Vent, 199,900 Btuh, max. 9.8 gpm
NC199-OD	Outdoor, 199,900 Btuh, max. 9.8 gpm
*NC1991-DVC	Low NOx, Indoor Concentric Vent, 199,900 Btuh, max. 9.8 gpm
*NC1991-OD	Low NOx, Outdoor, 199,900 Btuh, max. 9.8 gpm

*Available Spring 2012

NR111
Residential
Water Heater



Model No.	Description
NR111-DV	Indoor Direct Vent, 250,000 Btuh, max. 11.1 gpm
NR111-OD	Outdoor, 250,000 Btuh, max. 11.1 gpm
NR111-SV	Indoor/Outdoor, 250,000 Btuh, max. 11.1 gpm

**NRC111/
NRC1111**
Residential
Condensing
Water Heater



Model No.	Description
NRC111-DV	Indoor Direct Vent, 199,900 Btuh, max. 11.1 gpm
NRC111-SV	Indoor/Outdoor, 199,900 Btuh, max. 11.1 gpm
*NRC1111-DV	SV Convertible, LowNOx, Indoor Direct Vent, 199,900 Btuh, max. 11.1 gpm
*NRC1111-OD	LowNOx, Outdoor, 199,900 Btuh, max. 11.1 gpm

*Available Spring 2012

**NR98/
NR981**
Residential
Water Heater



Model No.	Description
NR98-DVC	Indoor Concentric Vent, 199,900 Btuh, max. 9.8 gpm
NR98-OD	Outdoor, 199,900 Btuh, max. 9.8 gpm
NR98-SV	Indoor/Outdoor, 199,900 Btuh, max. 9.8 gpm
*NR981-DVC	Low NOx, Indoor Concentric Vent, 199,900 Btuh, max. 9.8 gpm
*NR981-OD	Low NOx, Outdoor, 199,900 Btuh, max. 9.8 gpm
*NR981-SV	Low NOx, Indoor/Outdoor, 199,900 Btuh, max. 9.8 gpm

*Available Spring 2012

NRC98
Residential
Condensing
Water Heater



Model No.	Description
NRC98-DV	SV Convertible, Low NOx, Indoor Direct Vent, 180,000 Btuh, max. 9.8 gpm
NRC98-OD	Outdoor, 180,000 Btuh, max. 9.8 gpm

NR83
Residential
Water Heater



Model No.	Description
NR83-DVC	Low NOx, Indoor Concentric Vent, 180,000 Btuh, max. 8.3 gpm

Add “-NG” or “-LP” to the end of the model number to specify gas type.

NRC83
Residential
Condensing
Water Heater



Model No.	Description
NRC83-DV	SV Convertible, Low NOx, Indoor Direct Vent, 157,000 Btuh, max. 8.3 gpm
NRC83-OD	Outdoor, 157,000 Btuh, max. 8.3 gpm

NR71
Residential
Water Heater



Model No.	Description
NR71-OD	Outdoor, 180,000 Btuh, max. 7.1 gpm
NR71-SV	Indoor/Outdoor, 180,000 Btuh, max. 7.1 gpm

NR66
Residential
Water Heater



Model No.	Description
NR66-OD	Outdoor, 140,000 Btuh, max. 6.6 gpm
NR66-SV	Indoor/Outdoor, 140,000 Btuh, max. 6.6 gpm

NR50
Residential
Water Heater



Model No.	Description
NR50-OD	Outdoor, 120,000 Btuh, max. 5.0 gpm

Temp Rise (°F)	(NC380) Series	NR111 (NC250) Series	NRC111 (NCC199) Series	NRC98 NR98 (NC199) Series	NR83 Series	NRC83 Series	NR71 Series	NR66 Series	NR50 Series
30	13.2	11.1	11.1	9.8	8.3	8.3	7.1	6.6	5.0
35	13.2	11.1	10.6	9.2	8.1	7.8	7.1	6.6	5.0
40	13.2	10.5	9.3	8.4	7.6	7.3	7.1	5.7	5.0
45	13.2	9.3	8.4	7.5	6.7	6.5	6.3	5.3	4.2
50	12.5	8.4	7.4	6.7	6.1	5.8	5.8	4.6	3.9
55	11.3	7.6	6.8	6.1	5.4	5.4	5.2	4.2	3.5
60	10.4	7.0	6.2	5.6	5.0	4.9	4.8	3.8	3.3
65	9.6	6.5	5.8	5.2	4.7	4.6	4.4	3.5	3.0
70	8.9	6.0	5.3	4.8	4.3	4.2	4.1	3.3	2.8
75	8.3	5.6	5.0	4.5	4.1	4.0	3.8	3.1	2.6
80	7.8	5.3	4.6	4.2	3.8	3.7	3.6	2.9	2.5
85	7.3	4.9	4.4	4.0	3.6	3.5	3.4	2.7	2.3
90	6.9	4.7	4.1	3.7	3.4	3.2	3.2	2.6	2.2
95	6.6	4.4	3.9	3.5	3.2	3.1	3.0	2.4	2.1
100	6.2	4.2	3.7	3.4	3.0	2.9	2.9	2.3	2.0

MODEL	SUMMER WATER SUPPLY (70°F)	WINTER WATER SUPPLY (45°F)
NC380	5.3 SHOWERS AT 13.2 GPM	4.2 SHOWERS AT 10.4 GPM
NR111, NC250	4.4 SHOWERS AT 11.1 GPM	2.8 SHOWERS AT 7.0 GPM
NRC111, NCC199	4.1 SHOWERS AT 10.6 GPM	2.5 SHOWERS AT 6.2 GPM
NRC98, NR98, & NC199	3.7 SHOWERS AT 9.2 GPM	2.2 SHOWERS AT 5.6 GPM
NR83	3.3 SHOWERS AT 8.1 GPM	2.0 SHOWERS AT 5.0 GPM
NRC83	3.1 SHOWERS AT 7.8 GPM	2.0 SHOWERS AT 4.9 GPM
NR71	2.8 SHOWERS AT 7.1 GPM	1.9 SHOWERS AT 4.8 GPM
NR66	2.6 SHOWERS AT 6.6 GPM	1.5 SHOWERS AT 3.8 GPM
NR50	2.5 SHOWERS AT 5.0 GPM	N/A FOR WINTER WEATHER

Add “-NG” or “-LP” to the end of the model number to specify gas type.

0700757
Remote Controller
Outdoor
Junction Box



Model No.	Description	Qty/Box*
0700757	Remote Controller Outdoor Junction Box	1

H2F
H2Flow
Water Treatment



Model No.	Description	Qty/Box*
CH2F-***	Commercial H2Flow	***
H2F	H2Flow Anti-Scale System	1
H2F-C	H2Flow Replacement Cartridge	1

SS
Scale Shield
Water Treatment



Model No.	Description	Qty/Box*
SS-HB-1	Water Treatment for NR66, NR71, NR98, NRC111, NRC98, NRC83, NCC199 series	1
SS-HB-2	Water Treatment for NR111, NC250, NC380 series	1
HBC-1	Refill Cartridge for SS-HB-1	1
HBC-2	Refill Cartridge for SS-HB-2	1

IK-WV
Isolator
Valve Kit



Model No.	Description	Qty/Box*
IK-WV-200-1-SW	3/4" sweat iso valve kit with male 500K Btuh Pressure Relief Valve	1
IK-WV-200-1-TH	3/4" threaded iso valve kit with male 500K Btuh Pressure Relief Valve	1
IK-WV-300-1-SW	1" sweat iso valve kit with male 500K Btuh Pressure Relief Valve	1
IK-WV-300-1-TH	1" threaded iso valve kit with male 500K Btuh Pressure Relief Valve	1

IK-WV
Lead-Free
Isolator
Valve Kit



Model No.	Description	Qty/Box*
IK-WV-200-1-SW-LF	Lead Free 3/4" sweat iso valve kit with male 500K Btuh Pressure Relief Valve	1
IK-WV-200-1-TH-LF	Lead Free 3/4" threaded iso valve kit with male 500K Btuh Pressure Relief Valve	1
IK-WV-300-1-SW-LF	Lead Free 1" sweat iso valve kit with male 500K Btuh Pressure Relief Valve	1
IK-WV-300-1-TH-LF	Lead Free 1" threaded iso valve kit with male 500K Btuh Pressure Relief Valve	1

MR-2
Commercial
Multi-Rack
System



Model No.	Description	Qty/Box*
MR-2	Commercial multi-rack system	1

HTGSRV-1
Safety Relief Valve



Model No.	Description	Qty/Box*
HTGSRV-1	Safety Relief Valve for NH series	1

NC-1/NT20A
Condensate
Neutralizer Kit

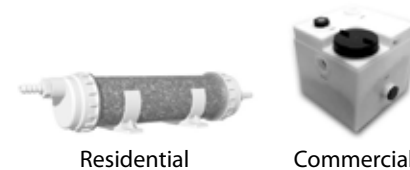

Model No.	Description	Qty/Box*
NC-1	Residential Condensate Neutralizer Kit	1
NT20A	Commercial Condensate Neutralizer Kit	1

PC
Pipe Cover



Model No.	Description	Qty/Box*
PC-1S	Pipe Cover (NR50, NR66, NR71 series)	1
PC-2S	Pipe Cover for NR98 (SV/OD)	1
PC-2S-GRY	Stone Gray Pipe Cover for NC199-OD	1
PC-3S	Pipe Cover (NR111 and NRC series)	1
PC-3S-SUS	Stainless Steel PC for NC250, NCC199 series	1
PC-4S-SUS	Stainless Steel PC for NC380	1
PC-5S	Pipe Cover for NR98-DVC, NR83-DVC	1
PC-5S-GRY	Stone Gray Pipe Cover for NC199-DVC	1

QC
Quick Connect
Cable



Model No.	Description	Qty/Box*
QC-1	Quick Connect Cable (2 units only)	1
QC-2	Quick Connect Cable (NR83-DVC and NRC98 series only)	1

RB
Recess Box



Model No.	Description	Qty/Box*
RB-500	Recess Box for NR66-OD	1
RB-600	Recess Box for NR71-OD	1
RB-700	Recess Box for NR98-OD	1
RB-900	Recess Box for NR111-OD, NRC98,83-OD	1

RC
Remote
Controller



Model No.	Description	Qty/Box*
RC-7649M	Remote Controller	1
RC-7650M	Remote Controller - Canada	1
RC-9018M	Remote Controller for 2012 Residential & Commercial units*	1

*2012 Residential Units: NRC1111, NRC98, NRC83, NR981
2012 Commercial Units: NCC1991, NC1991

RC-CORD

Remote Controller Cord



Model No.	Description	Qty/Box*
RC-CORD10	10 ft. length	1
RC-CORD26	26 ft. length	1

SKD7466

Neutralizer Cartridge



Model No.	Description	Qty/Box*
SKD7466	Neutralizer Cartridge	1

*For NRC111 AND NCC199

SC

System Controller



Model No.	Description	Qty
SC-201-12M	System Controller up to 12 units	1
SC-201-24M	System Controller up to 24 units	1
SC-201-6M	System Controller up to 6 units	1
SC-201-6M-EXT-DVC	System Controller for NC199-DVC*	1
SC-201-6M-EXT-OD	System Controller for NC199-OD	1
SCU-301-12M	System Controller up to 12 units for NCC1991 & NC1991	1
SC-301-6M	System Controller up to 6 units for NCC1991 & NC1991	1

*RC-Cords will need to be purchased

SKG7772

Freeze Protection Kit



Model No.	Description	Qty/Box*
SKG7772	Freeze Protection Kit for NR50-OD	1

TPG1-30

Temp/Pressure Gauge



Model No.	Description	Qty/Box*
TPG1-30	Temp/Pressure Gauge for NH	1

VPX-XXSTR

Stainless Steel Single-Wall Rigid Vent Pipe

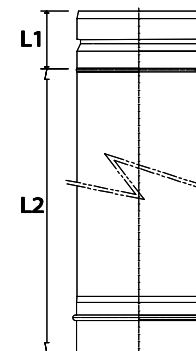

Model No.	Venting Series	L1	L2	Qty / Box
VP3-12STR	3" SUS	2.0"	12.0"	6
VP3-24STR	3" SUS	2.0"	24.0"	6
VP3-36STR	3" SUS	2.0"	36.0"	6
VP3-48STR	3" SUS	2.0"	48.0"	6
VP4-6STR	4" SUS	2.1"	6.0"	6
VP4-12STR	4" SUS	2.1"	12.0"	6
VP4-24STR	4" SUS	2.1"	24.0"	6
VP4-36STR	4" SUS	2.1"	36.0"	6
VP4-48STR	4" SUS	2.1"	48.0"	6
VP5-6STR	5" SUS	2.7"	6.0"	6
VP5-12STR	5" SUS	2.7"	12.0"	6
VP5-24STR	5" SUS	2.7"	24.0"	6
VP5-36STR	5" SUS	2.7"	36.0"	6
VP5-48STR	5" SUS	2.7"	48.0"	6

VPX-XXADJ

Stainless Steel Single-Wall Adjustable Vent Pipe

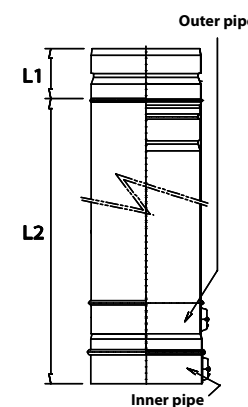

Model No.	Venting Series	L1	L2	Qty / Box
VP3-9.4ADJ	3" SUS	2.0"	6.8" - 9.1"	6
VP3-13.4ADJ	3" SUS	2.0"	9.5" - 14.6"	6
VP3-21.4ADJ	3" SUS	2.0"	15.4" - 26.5"	6
VP3-60ADJ	3" SUS	2.0"	36.0" - 60.0"	6
VP4-9.4ADJ	4" SUS	2.1"	6.8" - 9.1"	6
VP4-13.4ADJ	4" SUS	2.1"	9.5" - 14.6"	6
VP4-21.4ADJ	4" SUS	2.1"	15.4" - 26.5"	6
VP4-60ADJ	4" SUS	2.1"	36.0" - 60.0"	6
VP5-9.4ADJ	5" SUS	2.7"	6.8" - 9.1"	6
VP5-13.4ADJ	5" SUS	2.7"	9.5" - 14.6"	6
VP5-21.4ADJ	5" SUS	2.7"	15.4" - 26.5"	6

VPX-18FLEX

Stainless Steel Single-Wall Semi-Flexible Vent Pipe

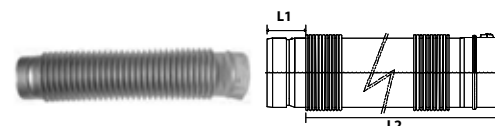

Model No.	Venting Series	L1	L2	Qty / Box
VP4-18FLEX	4" SUS	2.1"	6.2"	6
VP5-18FLEX	5" SUS	2.1"	6.2"	6

3" SUS	For NR66 Series
4" SUS	For NR71, NR98, NR111, NC199, NCC199, NC250, NH Boiler Series

5" SUS	For NC380 Series
Concentric SUS	For DVC Series

VPX-45ELB

Stainless Steel Single-Wall
45° Vent Pipe Elbow

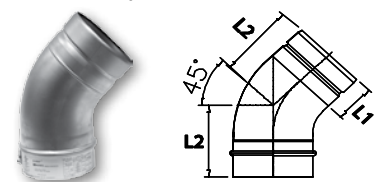

Model No.	Venting Series	L1	L2	Qty / Box
VP3-45ELB	3" SUS	2.0"	3.6"	6
VP4-45ELB	4" SUS	2.1"	4.0"	6
VP5-45ELB	5" SUS	2.7"	5.4"	6

VPX-90ELB

Stainless Steel Single-Wall
90° Vent Pipe Elbow

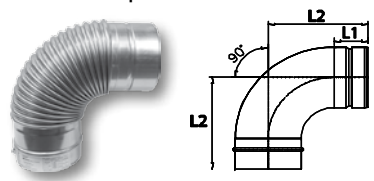

Model No.	Venting Series	L1	L2	Qty / Box
VP3-90ELB	3" SUS	2.0"	5.2"	6
VP4-90ELB	4" SUS	2.1"	6.2"	6
VP5-90ELB	5" SUS	2.7"	7.9"	6

DTX-V

Stainless Steel Single-Wall
Vent Pipe Vertical Drain Tee

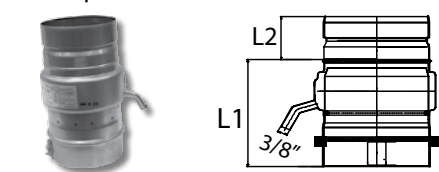

Model No.	Venting Series	L1	L2	Qty / Box
DT3-V	3" SUS	2.0"	5.1"	6
DT4-V	4" SUS	2.1"	5.1"	6
DT5-V	5" SUS	2.7"	6.2"	6

DTX

Stainless Steel Single-Wall
Vent Pipe Horizontal Drain Tee

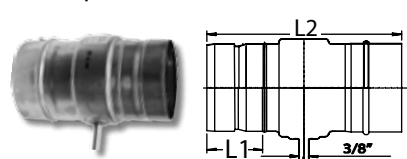

Model No.	Venting Series	L1	L2	Qty / Box
DT3	3" SUS	2.0"	7.1"	6
DT4	4" SUS	2.1"	7.2"	6
DT5	5" SUS	2.7"	8.0"	6

RC-X

Stainless Steel Single-Wall
Vent Pipe Rain Cap

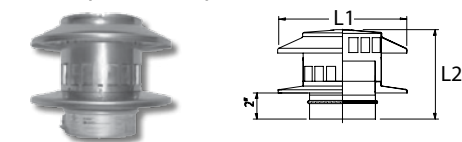

Model No.	Venting Series	L1	L2	Qty / Box
RC3	3" SUS	6.3"	6.8"	6
RC4	4" SUS	7.8"	6.6"	6
RC5	5" SUS	11.0"	7.2"	6

SCPX

Stainless Steel Single-Wall
Storm Collar Vent Pipe

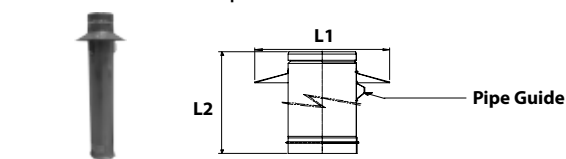

Model No.	Venting Series	L1	L2	Qty / Box
SCP4	4" SUS	2.1"	23.6"	6
SCP5	5" SUS	2.7"	25.2"	6

VTX-S

Stainless Steel Single-Wall Vent Pipe
Straight Termination w/ Birdscreen

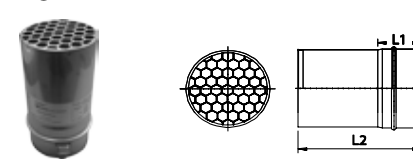

Model No.	Venting Series	L1	L2	Qty / Box
VT3-S	3" SUS	2.0"	5.9"	6
VT4-S	4" SUS	2.1"	6.2"	6
VT5-S	5" SUS	2.7"	7.9"	6

VTX-S45

Stainless Steel Single-Wall
45° Vent Pipe Termination w/ Birdscreen

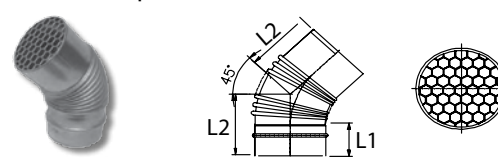

Model No.	Venting Series	L1	L2	Qty / Box
VT4-S45	4" SUS	2.1"	4.0"	6
VT5-S45	5" SUS	2.7"	5.4"	6

VTX-SH

Stainless Steel Single-Wall
Vent Pipe Termination w/ Hood

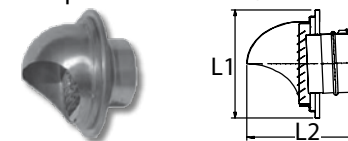

Model No.	Venting Series	L1	L2	Qty / Box
VT3-SH	3" SUS	3.2"	5.5"	6
VT4-SH	4" SUS	7.4"	6.1"	6
VT5-SH	5" SUS	7.4"	6.6"	6

VTX-SL

Stainless Steel Single-Wall
Vent Pipe Termination w/ Louver

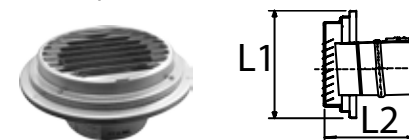

Model No.	Venting Series	L1	L2	Qty / Box
VT4-SL	4" SUS	7.4"	3.2"	6
VT5-SL	5" SUS	7.4"	3.7"	6

WTX

Stainless Steel Single-Wall
Vent Pipe Wall Thimble

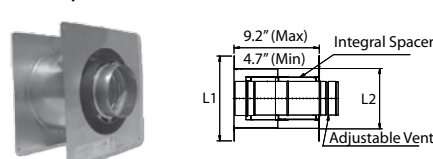

Model No.	Venting Series	L1	L2	Qty / Box
WT3	3" SUS	6.0"	4.0"	1
WT4	4" SUS	10.0"	7.0"	1
WT5	5" SUS	12.2"	10.7"	1

WTX-H-XX

Stainless Steel Single-Wall Vent Pipe
Adjustable Wall Thimble w/ Termination

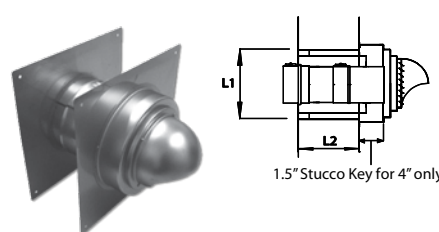

Model No.	Venting Series	L1	L2	Qty / Box
WT3-H-6	3" SUS	6.5"	5.0" - 6.0"	1
WT3-H-9	3" SUS	6.5"	7.0" - 9.0"	1
WT3-H-14	3" SUS	6.5"	9.0" - 14.5"	1
WT4-H-8-1	4" SUS	5.8"	4.1" - 7.8"	1
WT4-H-14-1	4" SUS	5.8"	7.8" - 14.0"	1
WT5-H-6	5" SUS	10.7"	6.0" - 8.0"	1
WT5-H-7	5" SUS	10.7"	7.0" - 8.0"	1
WT5-H-14	5" SUS	10.7"	10.5" - 14.5"	1

3" SUS	For NR66 Series
4" SUS	For NR71, NR98, NR111, NC199, NCC199, NC250, NH Boiler Series

5" SUS	For NC380 Series
Concentric SUS	For DVC Series

3" SUS	For NR66 Series
4" SUS	For NR71, NR98, NR111, NC199, NCC199, NC250, NH Boiler Series

5" SUS	For NC380 Series
Concentric SUS	For DVC Series

VT4-TS-XX

Stainless Steel Single-Wall Vent Pipe
(Sealed Combustion/Dual Pipe)
Short Termination

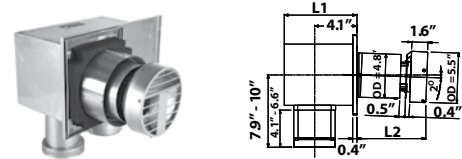

Model No.	Venting Series	Sleeve	L2	Qty
VT4-TS-5	4" SUS*	3.5" - 5.0"	7.0" - 8.5"	1
VT4-TS-8	4" SUS*	5.0" - 8.0"	8.5" - 12.0"	1
VT4-TS-14	4" SUS*	8.0" - 15.0"	12.0" - 18.0"	1
VT4-TS-27	4" SUS*	15.0" - 27.0"	18.0" - 30.5"	1

*For Stainless Steel Flue DV Models Only

VT4-TL-XX

Stainless Steel Single-Wall Vent Pipe
(Sealed Combustion/ Dual Pipe)
Long Termination

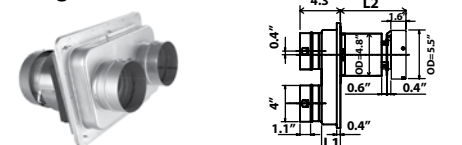

Model No.	Venting Series	Sleeve	L2	Qty
VT4-TL-5	4" SUS*	3.5" - 5.0"	7.0" - 8.5"	1
VT4-TL-8	4" SUS*	5.0" - 8.0"	8.5" - 12.0"	1
VT4-TL-14	4" SUS*	8.0" - 15.0"	12.0" - 18.0"	1
VT4-TL-27	4" SUS*	15.0" - 27.0"	18.0" - 30.5"	1

*For Stainless Steel Flue DV Models Only

VC-XX

Stainless Steel Vent Caps
for Single-Wall Vent Pipe
(for SV models)

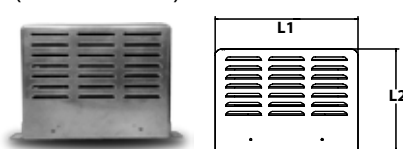

Model No.	Venting Series	L1	L2	Qty / Box
VC-3	3" SUS	7.9"	6.2"	6
VC-4-1	4" SUS	7.9"	6.2"	6
VC-4C	4" SUS*	8.0"	6.3"	6
VC-132	5" SUS	18.9"	7.6"	1

*For NRC111-SV / NCC199-SV Only

VPX-ADAPT-1

Stainless Steel Single-Wall
Appliance Adapter Vent Pipe



Model No.	Venting Series	L1	L2	Qty / Box
VP3-ADAPT-1	3" SUS	1.2"	4.9"	6
VP4-ADAPT-1	4" SUS	1.2"	4.9"	6

CVP-XSTR

Stainless Steel Double-Wall
Rigid Vent Pipe

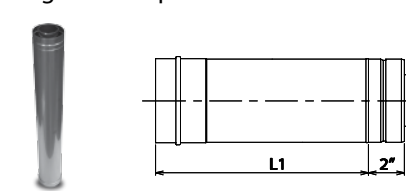

Model No.	Venting Series	L1	L2	Qty / Box
CVP-4STR	Concentric SUS	3.3"	-	6
CVP-12STR	Concentric SUS	11.8"	-	6
CVP-24STR	Concentric SUS	23.6"	-	6
CVP-36STR	Concentric SUS	35.4"	-	6

CVP-XXADJ

Stainless Steel Double-Wall
Adjustable Vent Pipe

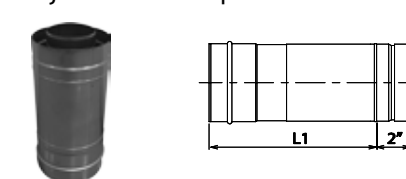

Model No.	Venting Series	L1	L2	Qty / Box
CVP-11ADJ	Concentric SUS	8.3" - 11.2"	-	6
CVP-16ADJ	Concentric SUS	11.0" - 16.7"	-	6
CVP-40ADJ	Concentric SUS	22.8" - 40.6"	-	6

CVP-45ELB

Stainless Steel Double-Wall
45° Vent Pipe Elbow

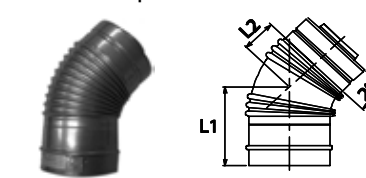

Model No.	Venting Series	L1	L2	Qty / Box
CVP-45ELB	Concentric SUS	5.3"	2.2"	6

CVP-90ELB

Stainless Steel Double-Wall
90° Vent Pipe Elbow

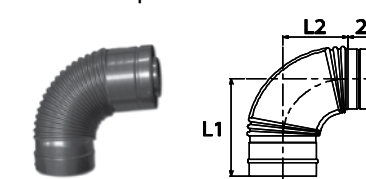

Model No.	Venting Series	L1	L2	Qty / Box
CVP-90ELB	Concentric SUS	8.1"	4.9"	6

CVP-90ADJELB

Stainless Steel Double-Wall
90° Adjustable Vent Pipe Elbow

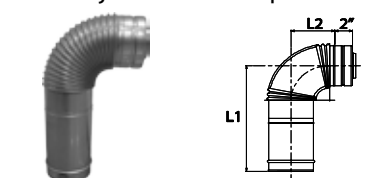

Model No.	Venting Series	L1	L2	Qty / Box
CVP-90ADJELB	Concentric SUS	12.6" - 15.8"	4.9"	6

CWF-90ELB

Stainless Steel Double-Wall 90°
Adjustable Vent Pipe Elbow
w/ Wall Flange

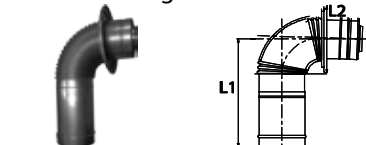

Model No.	Venting Series	L1	L2	Qty / Box
CWF-90ELB	Concentric SUS	12.6" - 15.8"	8.7"	6

3" SUS	For NR66 Series
4" SUS	For NR71, NR98, NR111, NC199, NCC199, NC250, NH Boiler Series

5" SUS	For NC380 Series
Concentric SUS	For DVC Series

3" SUS	For NR66 Series
4" SUS	For NR71, NR98, NR111, NC199, NCC199, NC250, NH Boiler Series

5" SUS	For NC380 Series
Concentric SUS	For DVC Series

CDT-V

Stainless Steel Double-Wall
Vent Pipe Vertical Drain Tee

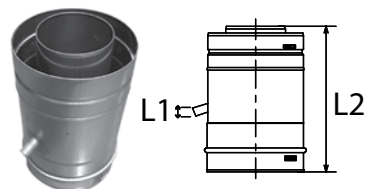

Model No.	Venting Series	L1	L2	Qty / Box
CDT-V	Concentric SUS	0.47"	8.3"	6

CRCAI-1

Stainless Steel Double-Wall
Vent Pipe Rain Cap

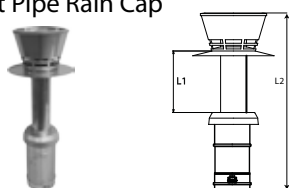

Model No.	Venting Series	L1	L2	Qty / Box
CRCAI-1	Concentric SUS	10.6"	26.5"	1

CVT-S

Stainless Steel Double-Wall Vent Pipe
Straight Termination w/ Birdscreen

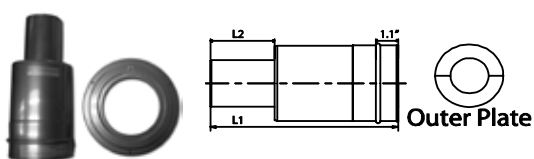

Model No.	Venting Series	L1	L2	Qty / Box
CVT-S	Concentric SUS	11.0"	3.9"	6

CWF

Stainless Steel Double-Wall
Vent Pipe w/ Wall Flange



Model No.	Venting Series	L1	L2	Qty / Box
CWF	Concentric SUS	2.0"	8.7"	6

CWT-H

Stainless Steel Double-Wall Vent Pipe
Builder's Edition Wall Thimble



Model No.	Venting Series	L1	L2	Qty / Box
CWT-H	Concentric SUS	Min. 3.5"	1.5"	1

VK3-H-PVC

PVC Concentric Horizontal
Termination Kit



Model No.	Venting Series	L1	L2	Qty / Box
VK3-H-PVC	3" PVC	39"	4.5"	1

PVT-HL

Plastic Horizontal Termination

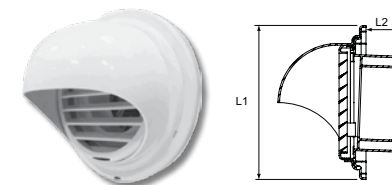

Model No.	Venting Series	L1	L2	Qty / Box
PVT-HL	3" PVC 4" PVC	7.5"	2.0"	6

VTX-PVCS

Stainless Steel Bird Screen
for PVC Termination

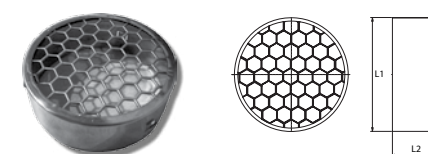

Model No.	Venting Series	L1	L2	Qty / Box
VT3-PVCS	3" PVC	2.8"	3.0"	6
VT4-PVCS	4" PVC	3.8"	3.0"	6

VPX-ADAPT-PVC

Stainless Steel PVC Adapter

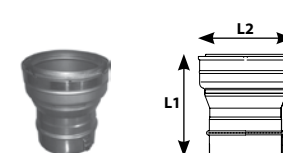

Model No.	Venting Series	L1	L2	Qty / Box
VP4x3-ADAPT-PVC	3" PVC*	5.5"	4.0"	6
VP4-ADAPT-PVC	4" PVC*	5.5"	5.0"	6

*For NCC199 Only

SV-CK-3

DV to SV Conversion Kit

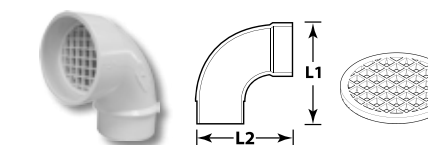

Model No.	Venting Series	L1	L2	Qty / Box
SV-CK-3	3" PVC*	6.7"	6.4"	6

* For NRC98 and NRC83 Only

3" SUS	For NR66 Series
4" SUS	For NR71, NR98, NR111, NC199, NCC199, NC250, NH Boiler Series

5" SUS	For NC380 Series
Concentric SUS	For DVC Series

3" PVC	For NRC111, NCC199, NRC98, NRC83, NRC1111, NCC1991
4" PVC	For NRC111, NCC199, NRC98, NRC83, NRC1111, NCC1991

ARFX
Stainless Steel Angled Roof Flashing

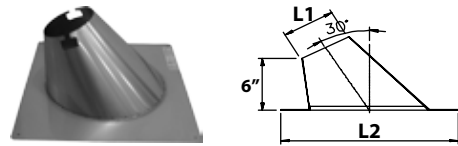

Model No.	Venting Series	L1	L2	Qty
ARF3	3" SUS	5.0"	16.0"	1
ARF4	4" SUS	6.0"	17.0"	1
ARF5	5" SUS	7.0"	18.0"	1
CARF-1	Concentric SUS*	8.0"	16.0"	1

*0-45 Degree Roof Pitch

FRFX
Stainless Steel Flat Roof Flashing

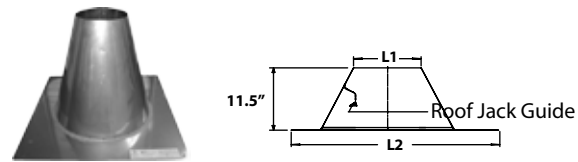

Model No.	Venting Series	L1	L2	Qty
FRF4	4" SUS	5.3"	17.0"	1
FRF5	5" SUS	6.3"	18.0"	1

CRX-
Stainless Steel Cosmetic Ring

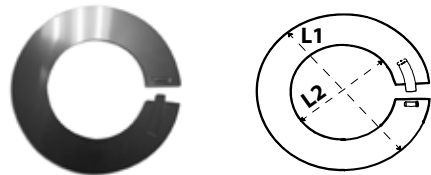

Model No.	Venting Series	L1	L2	Qty / Box
CR3-SUS	3" SUS	6.9"	3.9"	1
CR4-SUS	4" SUS	7.2"	4.3"	1
CR5-SUS	5" SUS Concentric SUS	9.9"	5.4"	1
CR3-PVC	3" PVC	7.0"	4.0"	1
CR4-PVC	4" PVC	7.8"	4.8"	1

FSX
Stainless Steel Fire Stop

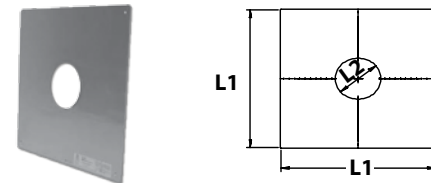

Model No.	Venting Series	L1	L2	Qty
FS3	3" SUS	15.0"	3.4"	6
FS4	4" SUS	18.0"	4.4"	6
FS5	5" SUS	20.4"	5.4"	6

SCX
Stainless Steel Support Clamp

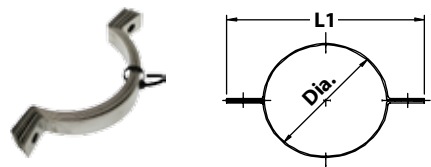

Model No.	Venting Series	L1	L2	Qty
SC3	3" SUS	6.0"	-	5 Sets
SC4	4" SUS	6.0"	-	5 Sets
SC5	5" SUS	7.0"	-	5 Sets

SCRX
Stainless Steel Storm Collar Ring

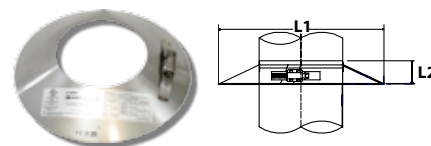

Model No.	Venting Series	L1	L2	Qty
SCR3	3" SUS	7.8"	3.0"	6
SCR4	4" SUS	7.9"	4.0"	6
CSCR	5" SUS	9.1"	4.0"	6
CSCR-1	Concentric SUS	9.1"	4.0"	6

SS3-X
Stainless Steel Support Straps
(3" SUS Venting Series)

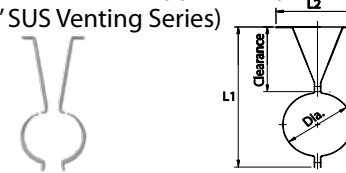

Model No.	Clearance	L1	L2	Qty
SS3-1	1"	4.6"	4.0"	5 Sets
SS3-2	2"	5.6"	4.0"	5 Sets
SS3-3	3"	6.6"	4.0"	5 Sets
SS3-4	4"	7.6"	4.0"	5 Sets

SS4-X
Stainless Steel Support Straps
(4" SUS Venting Series)

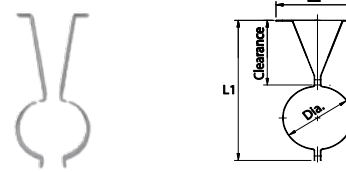

Model No.	Clearance	L1	L2	Qty
SS4-1	1"	5.7"	4.7"	5 Sets
SS4-2	2"	6.6"	4.7"	5 Sets
SS4-4	4"	8.7"	4.7"	5 Sets
SS4-6	6"	10.7"	4.7"	5 Sets

SS5-X
Stainless Steel Support Straps
(5" & Concentric SUS Venting Series)

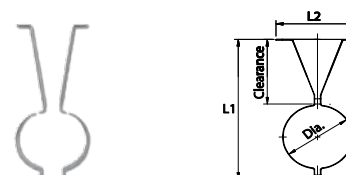

Model No.	Clearance	L1	L2	Qty
SS5-1	1"	6.8"	6.0"	5 Sets
SS5-2	2"	7.8"	6.0"	5 Sets
SS5-4	4"	9.8"	6.0"	5 Sets
SS5-6	6"	11.8"	6.0"	5 Sets

RJX
Stainless Steel Roof Jack

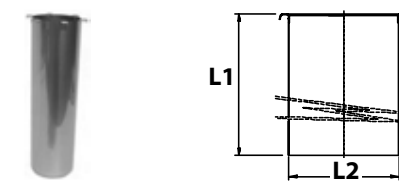

Model No.	Venting Series	L1	L2	Qty
RJ3	3" SUS	18.0"	4.0"	6
RJ4	4" SUS	18.0"	5.0"	6
RJ5	5" SUS	18.0"	6.0"	6

BG
Stainless Steel Bug Guard



Model No.	Venting Series	Description	Qty
BG-DV	4" SUS	For TS/TL Termination	1
BG-DVC-H	Concentric SUS	For CVK-H Series	1
BG-DVC-V	Concentric SUS	For CVK-V Series	1

* Image & drawing shown: BG-DVC-V

FP-X
Stainless Steel Face Plates

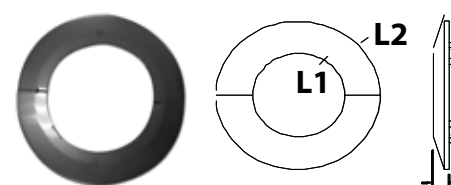

Model No.	Venting Series	L1	L2	Qty
FP-4	4" SUS*	4.9"	7.9"	1
FP-5-OUT	Concentric SUS	6.7"	8.7"	1

* For VT4-TS/TL Terminations Only

3" SUS	For NR66 Series
4" SUS	For NR71, NR98, NR111, NC199, NCC199, NC250, NH Boiler Series

5" SUS	For NC380 Series
Concentric SUS	For DVC Series

3" SUS	For NR66 Series
4" SUS	For NR71, NR98, NR111, NC199, NCC199, NC250, NH Boiler Series

5" SUS	For NC380 Series
Concentric SUS	For DVC Series

VK4-V1

Stainless Steel Single-Wall
Vent Pipe Vertical Kit

Model No.	Venting Series	Qty/Box
VK4-V1	4" SUS	1

CVK-V-1

Stainless Steel Double-Wall
Vent Pipe Vertical Kit

Model No.	Venting Series	Qty/Box
CVK-V-1	Concentric SUS*	1

* (0 - 45 Degree Roof Pitch)

VK4-H-XX-1

Stainless Steel Single-Wall
Vent Pipe Horizontal Kit

Model No.	Venting Series	Qty/Box
VK4-H-8-1	4" SUS*	1
VK4-H-14-1	4" SUS**	1

* (4.1" - 7.4" Wall Thickness)

** (7.4" - 14" Wall Thickness)

CVK-H

Stainless Steel Double-Wall
Vent Pipe Horizontal Kit

Model No.	Venting Series	Qty/Box
CVK-H	Concentric SUS*	1
CVK-H2	Concentric SUS**	1

* (5.8" - 13.2" Wall Thickness)

** (10.3" - 17.8" Wall Thickness)

CVK-SNRK

Stainless Steel Double-Wall
Vent Pipe Horizontal Snorkel Kit

Model No.	Venting Series	Qty/Box
CVK-SNRK	Concentric SUS	1

Horizontal- Kits

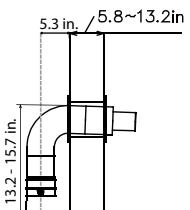
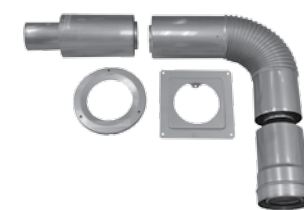

Standard Wall Kit
Includes inner & outer plates
CVK-H
Wall Thickness Range
From 5.8"-13.2"

Thick Wall Kit
Includes inner & outer plates
CVK-H2
Wall Thickness Range
From 10.3"-17.8"



Horizontal- Build Your Own

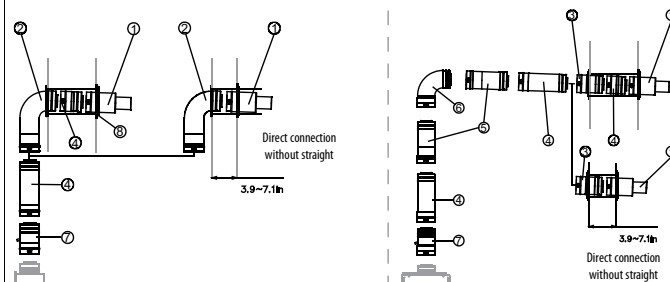

No	1	2	3	4	5	6	7
Description	Straight Bird Screen w/ Outer Plate	90° Adj w/ Wall Flange	Straight Vent Pipe w/ Wall Flange	Straight	Adjustable	45/ 90 Degree	Drain Tee
Part Number	CVT-S	CFW-90ELB	CFW	CVP-4/12/24/36STR	CVP-11/16/40ADJ	CVP-45/90ELB	CDT-V

Vertical Kit
CVK-V-1
(0-45 Degrees)

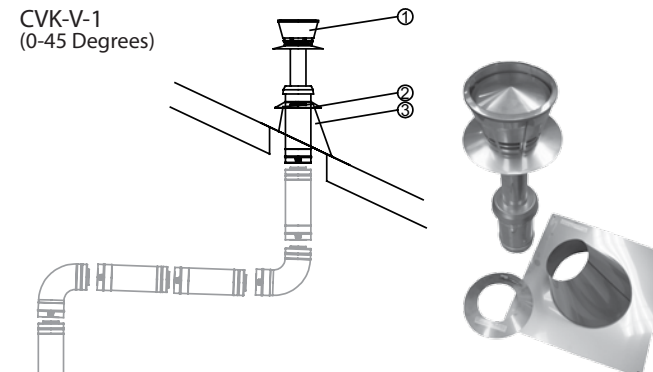

CVK-V-1 Contents		
No	Description	Part Number
1	Concentric Rain Cap	CRCAI-1
2	Storm Collar	CSCR-1
3	Adjustable Roof Flashing (0-45 Degrees)	CARF-1



Snorkel Kit

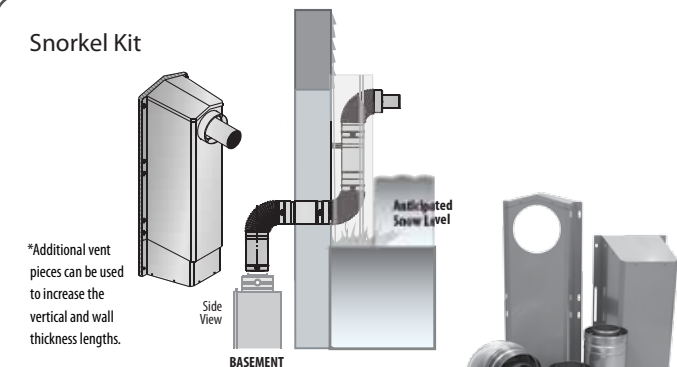

*Additional vent pieces can be used to increase the vertical and wall thickness lengths.

Snorkel Kit (CVK-SNRK) Contents		
PCS	Description	Part #
1	Snorkel case top	SNRK-C1
2	Snorkel case bottom	SNRK-C2
3	Concentric 11" adjustable vent pipe	CVP-11ADJ
4	Concentric 16" adjustable vent pipe	CVP-16ADJ
5	Concentric snorkel termination elbow	CVT-SNRK-90ELB
6	Concentric 90 degree elbow	CVP-90ELB
7	Concentric 90 degree adjustable elbow	CVP-90ADJELB
8	Adjustable support strap	SSS-3ADJ
9	Screw set	S-12



N-Vent Vertical Vent Kit
VK4-V1

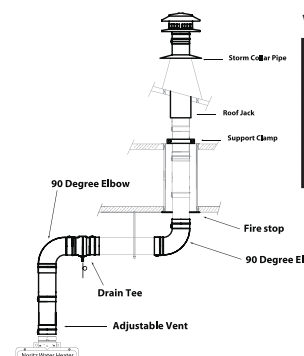

Vertical Kit Contains:

Description	Part Number	Quantity
Drain Tee	DT4	1
90 Degree Elbow	VP4-90ELB	2
Firestop	FS4	1
Support Clamp	SC4	1
Roof Jack	RJ4	1
Storm Collar Pipe	SCP4	1
Rain Cap	RC4	1
9" - 13.4" Adjustable Vent	VP4-13.4ADJ	1



N-Vent Horizontal Vent Kit
VK4-H-*

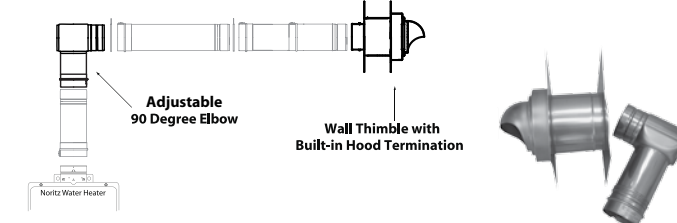

Horizontal Kit Contains:

Description	Part Number	Quantity
Wall Thimble with Built-in Hood Termination	WT4-H-#-1 (# Based on wall thickness)	1
Vertical Adjustment Range (7.5" - 11")	VP4-90ADJELB	1

Wall Thickness	Venting Kit Number
4.1" - 7.4"	VK4-H-8-1
7.4" - 14"	VK4-H-14-1



3" SUS	For NR66 Series
4" SUS	For NR71, NR98, NR111, NC199, NCC199, NC250, NH Boiler Series

5" SUS	For NC380 Series
Concentric SUS	For DVC Series



Headquarters

11160 Grace Avenue
Fountain Valley, CA 92708
Phone: 714.433.2905
Fax: 714.241.1514

www.noritz.com/pro
Toll Free: 888.382.6568

